

# ADANLOCK ARCHITECTURAL WALL SYSTEMS

## 478 SERIES - STANDARD DETAILS

VERTICAL  
MULLION  
POSTS

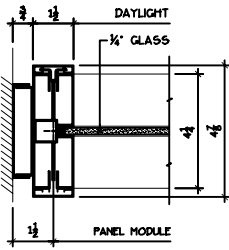

GLASS PANEL WALL STARTER

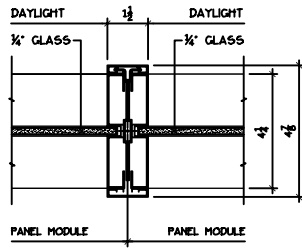

GLASS PANEL - INTERMEDIATE MULLION

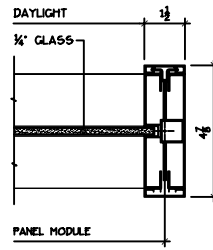

GLASS PANEL - FINISHED END POST

DOOR  
FRAME  
JAMBS

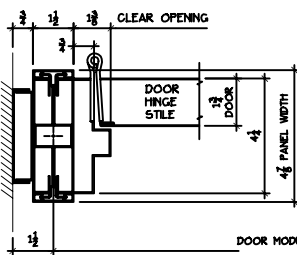

DOOR FRAME AT WALL START

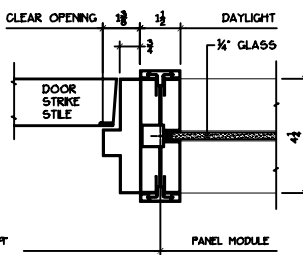

DOOR FRAME AT GLASS PANEL

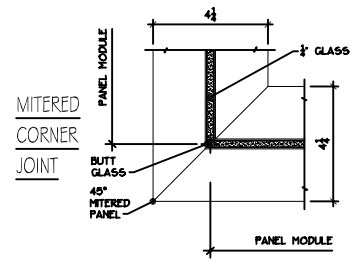

BUTT-END GLASS  
MITERED JOINT

GLASS PANEL DETAILS

CORNER  
POST  
DETAILS

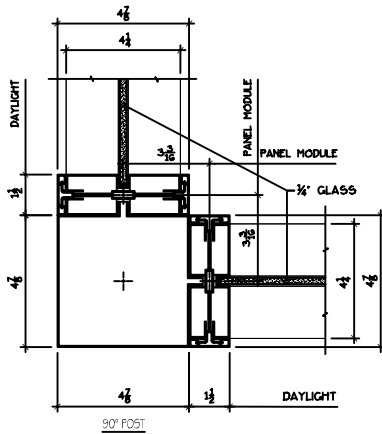

90° POST

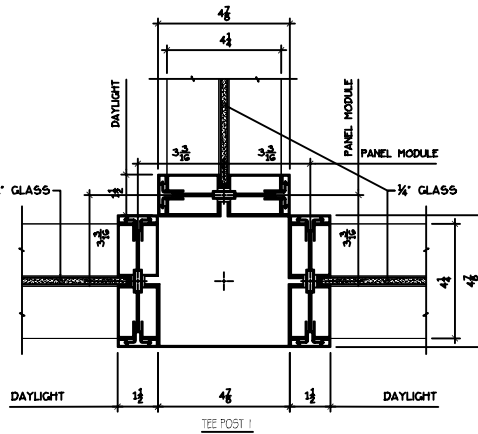

TEE POST 1

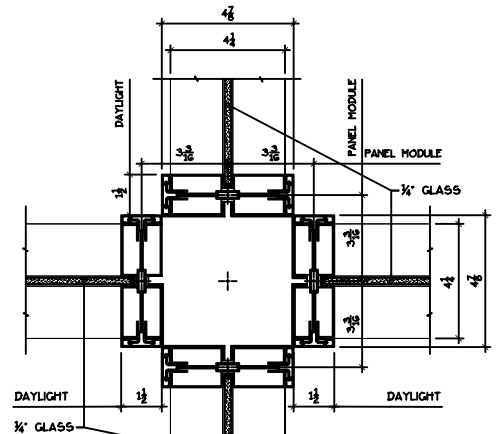

4-WAY POST

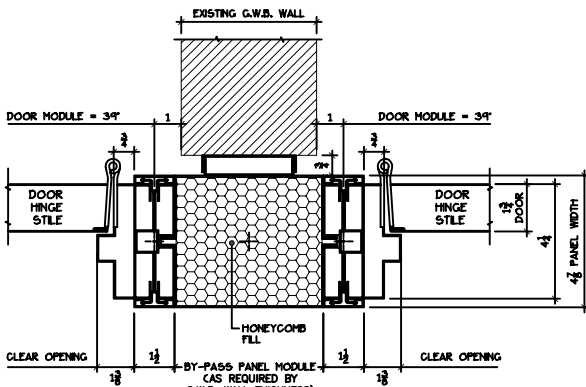

BY-PASS PANEL AT DOOR FRAMES

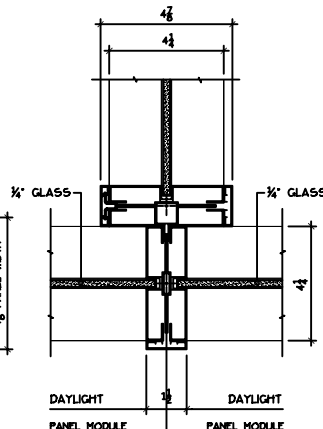

TEE POST 2

BY-PASS  
PANEL

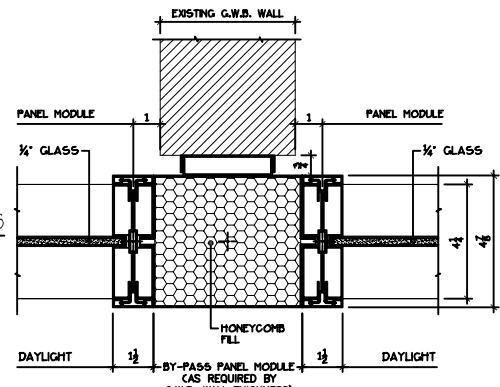

BY-PASS PANEL AT GLASS PANELS